

A number of sizes and styles are available from existing tooling. Some parts may be available from stock although they are normally manufactured to meet customers' requirements.

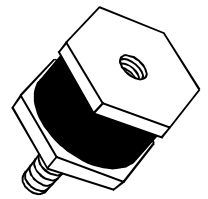

Part No. HEX-BF1235

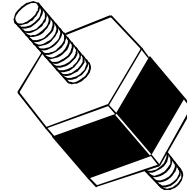
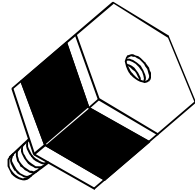
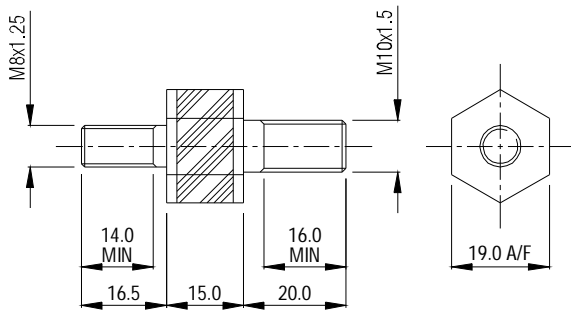

Part No. HEX-BF1179

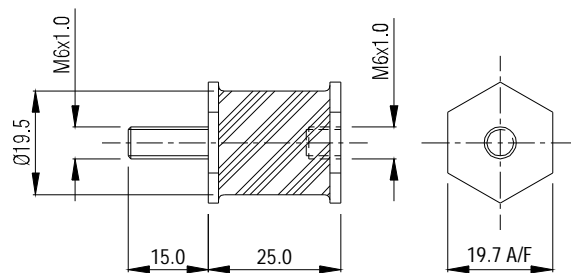

Part No. HEX-BF1215

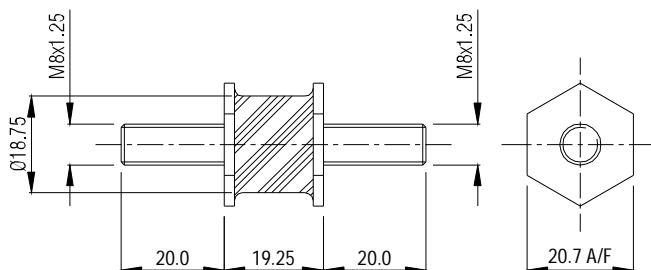

Part No. HEX-BF1200

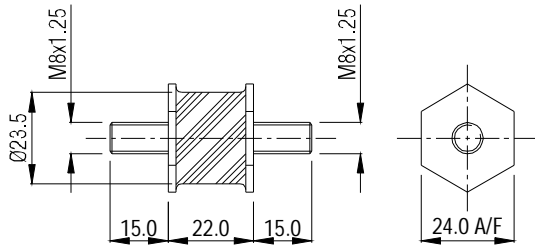

Part No. HEX-BF1184

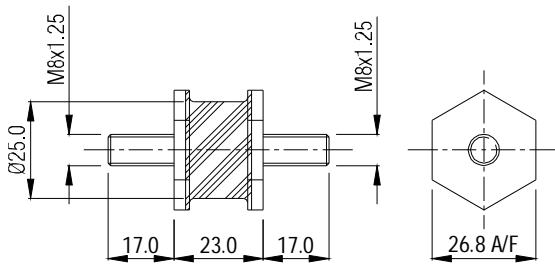

Part No. HEX-BF1089

