

These parts are specially manufactured from existing tooling and are used for high impact energy absorption. Minimum order quantities will apply.

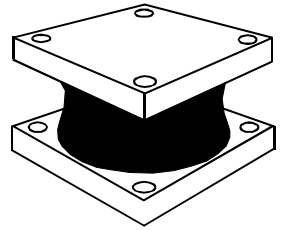

Part No. MTG-MTG1210

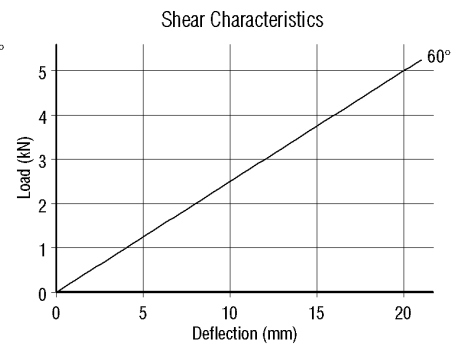
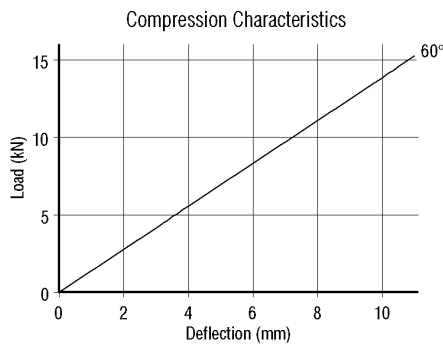
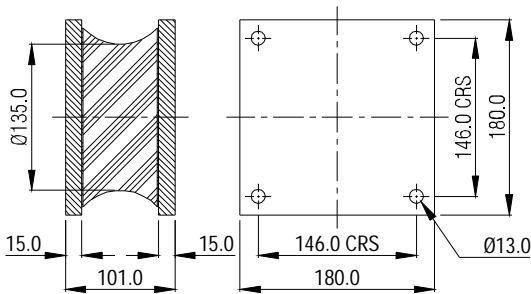

Part No. MTG-MTG1214

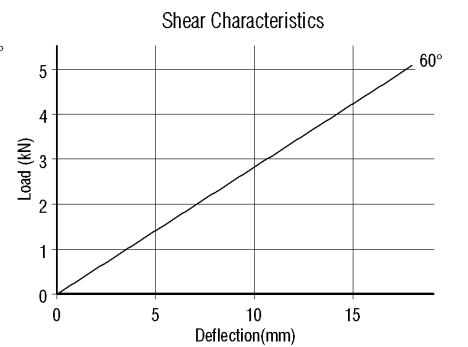
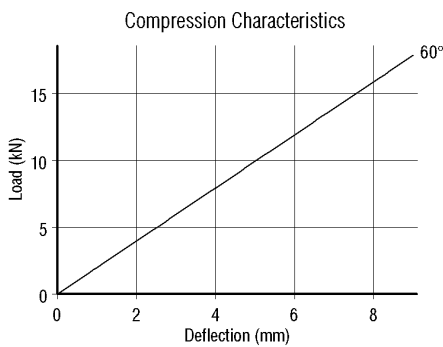
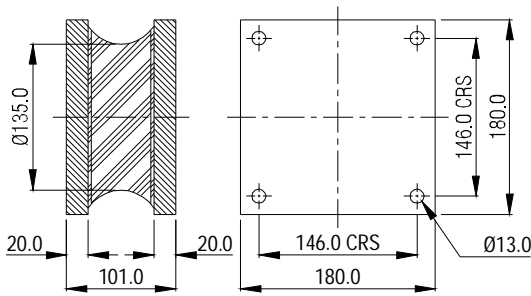

Part No. MTG-MTG1218

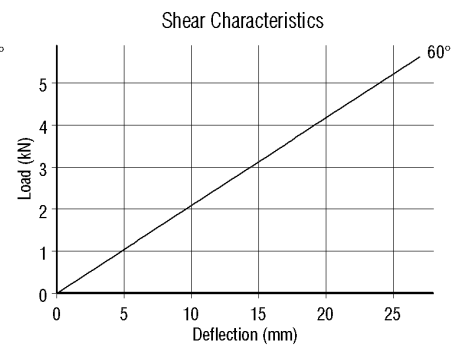
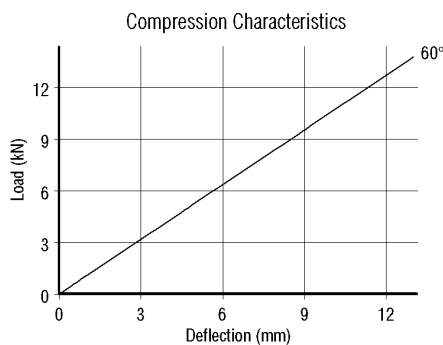
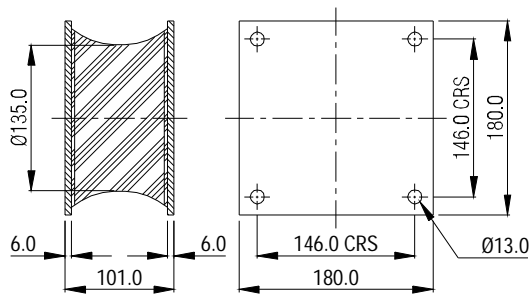

Part No. MTG-MTG1227

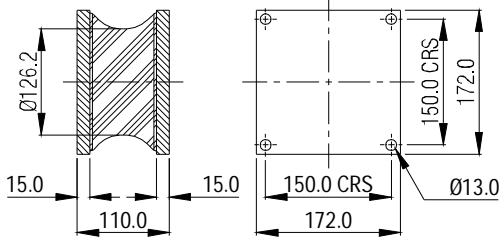

Compression Characteristics

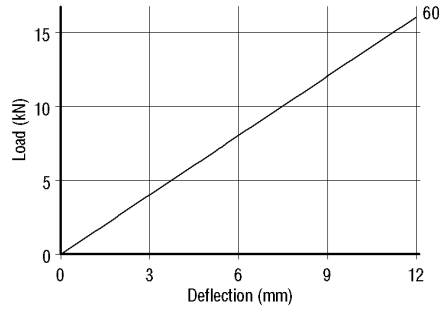

Shear Characteristics

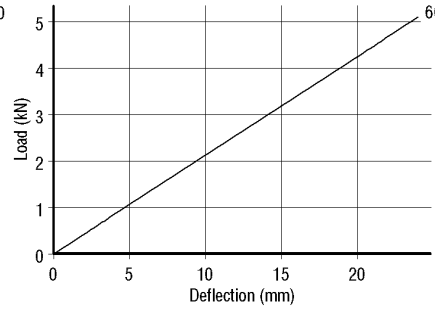

Part No. MTG-MTG1247

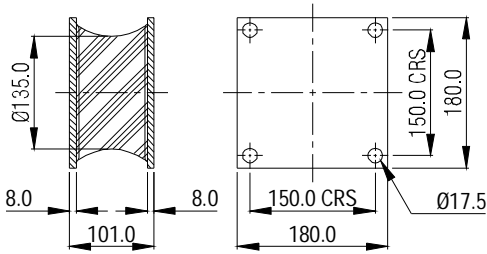

Compression Characteristics

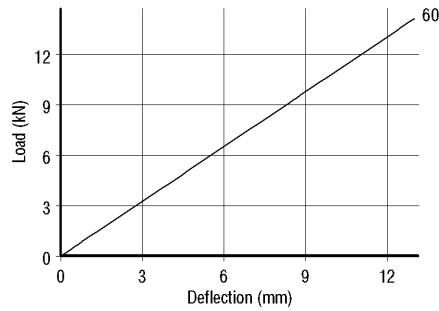

Shear Characteristics

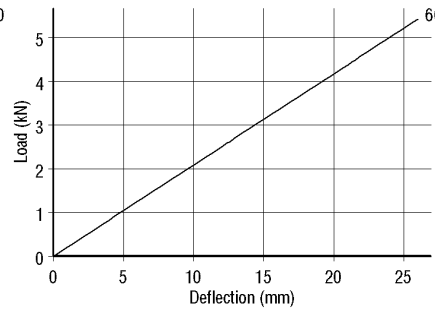

Part No. MTG-MTG1258

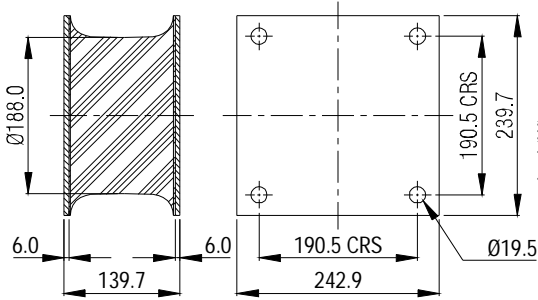

Compression Characteristics

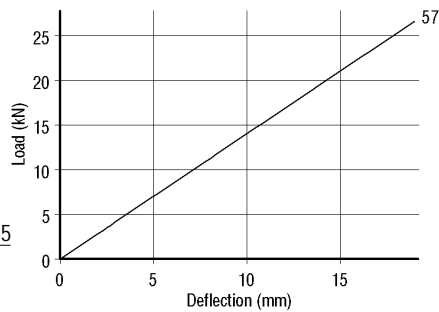

Shear Characteristics

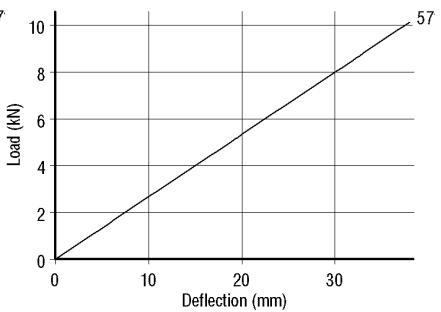

Part No. MTG-MTG1367

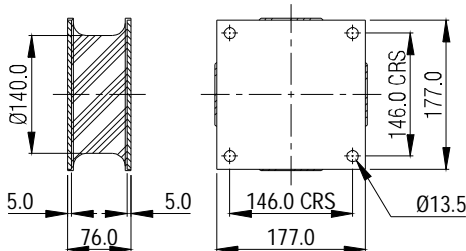

Compression Characteristics

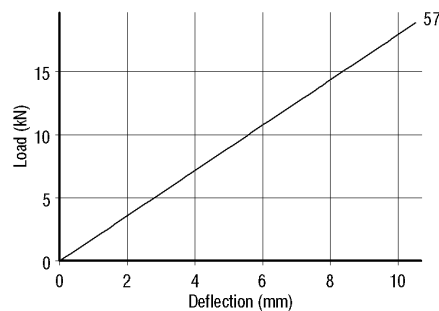

Shear Characteristics

