

A range of sizes and styles is available from existing tooling, with some held in stock. Parts may be subject to minimum order quantities. They are generally used in compression though some styles can be used in shear.

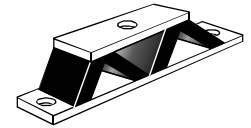

Part No. V-MTG1438

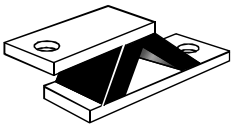
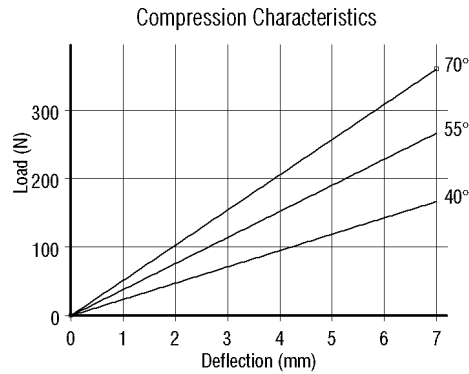
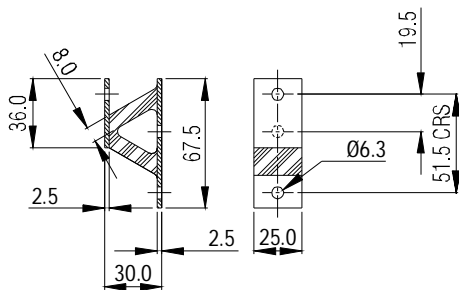

Part No. V-MTG1439

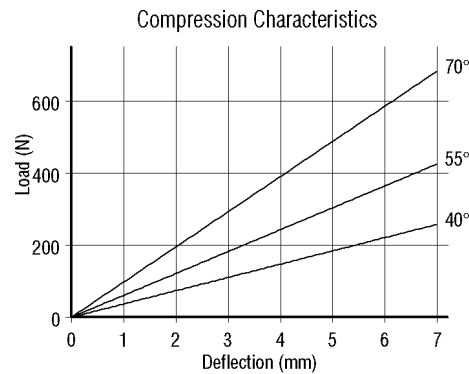
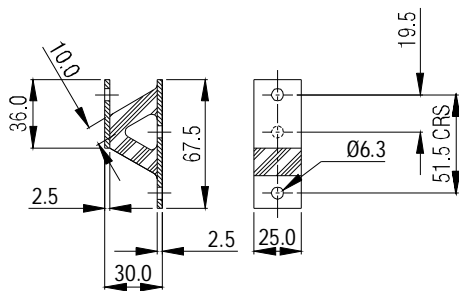

Part No. W-MTG1437

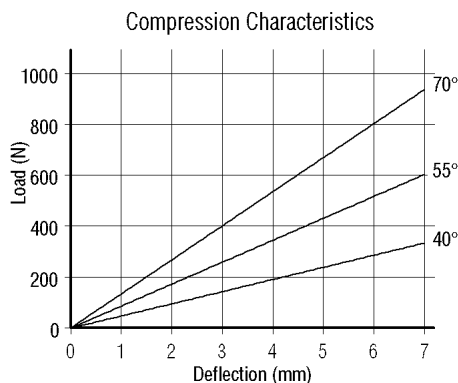
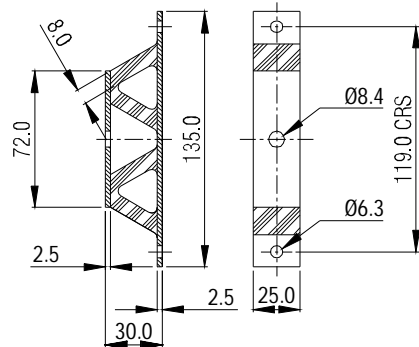

Part No. W-MTG1446

